

HK 3490/HK 3390 Stereo Receiver

OWNER'S MANUAL

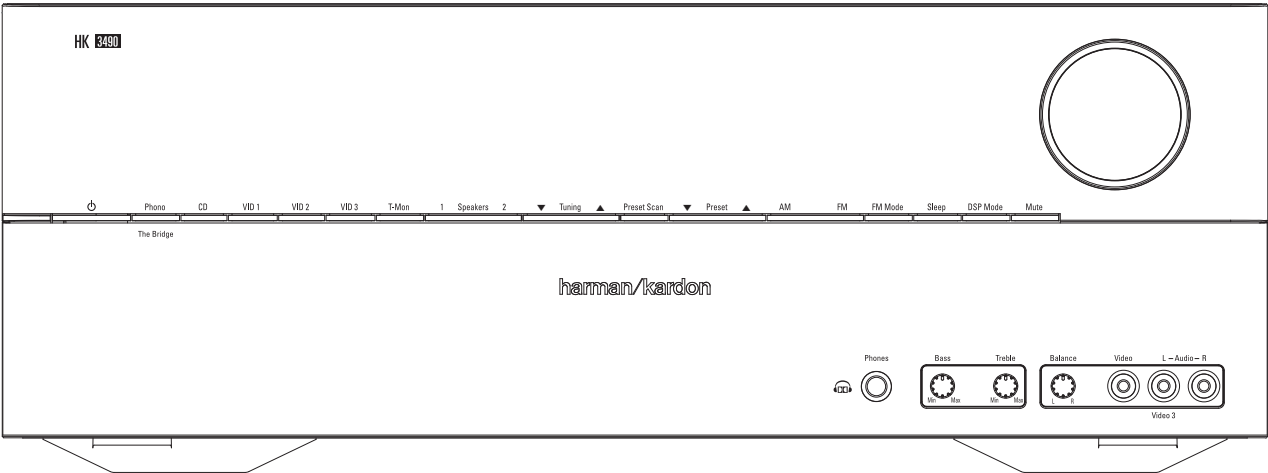

Table of Contents

- 3 Introduction
- 3 Important Information
- 4 Front Panel Controls
- 6 Rear Panel Connections
- 8 Remote Control Functions
- 10 Installation and Connections
- 12 Operation
 - 12 Basic Operation
 - 12 Source Selection
 - 13 Tuner Operation
 - 14 RDS Operation
 - 15 Tape Recording
 - 15 Memory Backup
 - 15 Processor Reset
 - 15 Using "The Bridge" iPod docking
 - 16 Using the Remote Control
- 17 Troubleshooting Guide
- 18 Technical Specifications

Declaration of Conformity



We, Harman Consumer International
2, Route de Tours, 72500 Château-du-Loir,
FRANCE

declare in own responsibility, that the product described
in this owner's manual is in compliance with technical
standards:

EN55013(2001) & + A2(2006)

EN55020(2002) & + A2(2005)

EN60065:2002

EN61000-3-2(2000)+A2(2005)

EN61000-3-3 (1995)+A1(2001)+A2(2005)

EN61000-4-2(1995) & + A1(1998) & + A2(2001)

EN61000-4-3(2002) & + A1(2002)

EN61000-4-4(2004)

Jurjen Amsterdam
Harman Consumer Group, Inc.
01/08

Typographical Conventions

In order to help you use this manual with the remote control, front-panel controls and rear-panel connections, certain conventions have been used.

EXAMPLE – (bold type) indicates a specific remote control or front-panel button, or rear-panel connection jack

EXAMPLE – (OCR type) indicates a message that is visible on the front-panel information display

1 – (number in a square) indicates a specific front panel control

A – (letter in a circle) indicates a button or indicator on the remote

1 – (number in a circle) indicates a rear panel connection

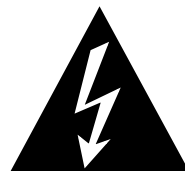

CAUTION

**RISK OF ELECTRIC SHOCK
DO NOT OPEN**



CAUTION: TO REDUCE THE RISK OF ELECTRIC SHOCK, DO NOT REMOVE COVER (OR BACK). NO USER-SERVICEABLE PARTS INSIDE. REFER SERVICING TO QUALIFIED SERVICE PERSONNEL.



The lightning flash with arrowhead symbol, within an equilateral triangle, is intended to alert the user to the presence of uninsulated "dangerous voltage" within the product's enclosure that may be of sufficient magnitude to constitute a risk of electric shock to persons.



The exclamation point within an equilateral triangle is intended to alert the user to the presence of important operating and maintenance (servicing) instructions in the literature accompanying the appliance.

WARNING: TO REDUCE THE RISK OF FIRE OR ELECTRIC SHOCK, DO NOT EXPOSE THIS APPLIANCE TO RAIN OR MOISTURE.

Introduction

Important Safety Information

READ THIS BEFORE OPERATING YOUR UNIT

Do not install this equipment in a confined space such as a case or similar – away from direct sunlight, heat sources, vibration, dust, moisture, and/or cold. Avoid installing this unit where foreign object may fall onto this unit and/or this unit may be exposed to liquid dripping or splashing.

On the top of this unit, do not place:

- Burning objects (i.e. candles), as they may cause fire, damage to this unit, and/or personal injury.
- Containers with liquid in them, as they may fall and liquid may cause electrical shock to the user and/or damage to this unit.

Do not cover this unit with a newspaper, tablecloth, curtain, etc. in order not to obstruct heat radiation. If the temperature inside this unit rises, it may cause fire, damage to this unit, and/or personal injury.

Install this unit near the AC outlet and where the AC power plug can be reached easily.

This unit is not disconnected from the AC power source as long as the ON/OFF Switch on the Rear Panel in ON. This state is called the standby mode. In this state, this unit is designed to consume a very small quantity of power.

WARNING. TO REDUCE THE RISK OF FIRE OR ELECTRIC SHOCK, DO NOT EXPOSE THIS APPLIANCE TO RAIN OR MOISTURE.

Congratulations! With the purchase of the Harman Kardon HK 3490/HK 3390 you are about to begin many years of listening enjoyment.

While sophisticated systems are hard at work within the HK 3490/HK 3390 to make all of this happen, hookup and operation are simple. Color-keyed connections and a comprehensive remote control make the HK 3490/HK 3390 easy to use.

To obtain maximum enjoyment from your new receiver, we urge you to take a few minutes to read through this manual. This will ensure that connections to speakers, source playback units and other external devices are made properly. In addition, a few minutes spent learning the functions of the various controls will enable you to take advantage of all the power the HK 3490/HK 3390 is able to deliver.

If you have any questions about this product, its installation or operation, please contact your dealer. He is your best local source of information.

Description and Features

Harman Kardon's HK 3490/HK 3390 is a full-featured Stereo receiver, with seven inputs and an FM stereo/FM/AM tuner with RDS capabilities that provide for the utmost flexibility. A high-quality phono input is available so that you may continue to enjoy your existing record collection as well as the latest CD recordings.

The HK 3490/HK 3390's powerful amplifier uses traditional Harman Kardon High-Current Design philosophies to meet the wide dynamic range of any program selection.

Harman Kardon invented the high-fidelity receiver more than fifty years ago. With state-of-the-art features and time-honored circuit designs, the HK 3490/HK 3390 is one of the finest receivers ever offered by Harman Kardon.

- **Harman Kardon Designed High-Current, Ultrawide Bandwidth Amplifier**
- **Dolby Virtual Speaker for true surround experience from just two loudspeakers.**
- **Four video inputs and a recording output**
- **Front-panel audio/video inputs**
- **Phono Input Section**
- **Speaker 1/Speaker 2 Outputs for High- Quality Sound in Two Locations**
- **Pre-Out/Main-In jacks for use with External Amplifiers, Equalizers or Speaker Processors**
- **System Remote Control with Numeric Keys**
- **Subwoofer Output**
- **Tuner with RDS Data Program Information Displays**
- **Connects to Harman Kardon's  Bridge (optional) for charging, playback and control of a compatible Apple® iPod® device**

Important Information

Verify Line Voltage Before Use

Your HK 3490/HK 3390 has been designed for use with 220-240-volt AC current. Connection to a line voltage other than that for which it is intended can create a safety and fire hazard, and may damage the unit.

If you have any questions about the voltage requirements for your specific model, or about the line voltage in your area, contact your selling dealer before plugging the unit into a wall outlet.

Do Not Open the Cabinet

There are no user-serviceable components inside this product. Opening the cabinet may present a shock hazard, and any modification to the product will void your guarantee. If water or any metal object such as a paper clip, wire or staple accidentally falls inside the unit, disconnect it from the AC power source immediately, and consult an authorized service station.

Installation Location

- To assure proper operation, and to avoid the potential for safety hazards, place the unit on a firm and level surface, that can support the weight of the product.
- Make certain that proper space is provided both above and below the unit for ventilation. If this product will be installed in a cabinet or other enclosed area, make certain that there is sufficient air movement within the cabinet. Under some circumstances a fan may be required.
- Do not place the unit directly on a carpeted surface.
- Avoid installation in extremely hot or cold locations, or an area that is exposed to direct sunlight or heating equipment.
- Avoid moist or humid locations.
- Do not obstruct the ventilation slots on the top of the unit, or place objects directly over them.

Cleaning

When the unit gets dirty, wipe it with a clean, soft, dry cloth. If necessary, wipe it with a soft cloth dampened with mild soapy water, then a fresh cloth with clean water. Wipe dry immediately with a dry cloth. NEVER use benzene, aerosol cleaners, thinner, alcohol or any other volatile cleaning agent. Do not use abrasive cleaners, as they may damage the finish of metal parts. Avoid spraying insecticide near the unit.

Moving the Unit

Before moving the unit, be certain to disconnect any interconnection cords with other components, and make certain that you disconnect the unit from the AC outlet.

Unpacking

The carton and shipping materials used to protect your new receiver during shipment were specially designed to cushion it from shock and vibration. We suggest that you save the carton and packing materials for use in shipping if you move, or should the unit ever need repair.

If you do not wish to save the packaging materials, please note that the carton and other sections of the shipping protection are recyclable. Please respect the environment and discard those materials at a local recycling center.

Front Panel Controls

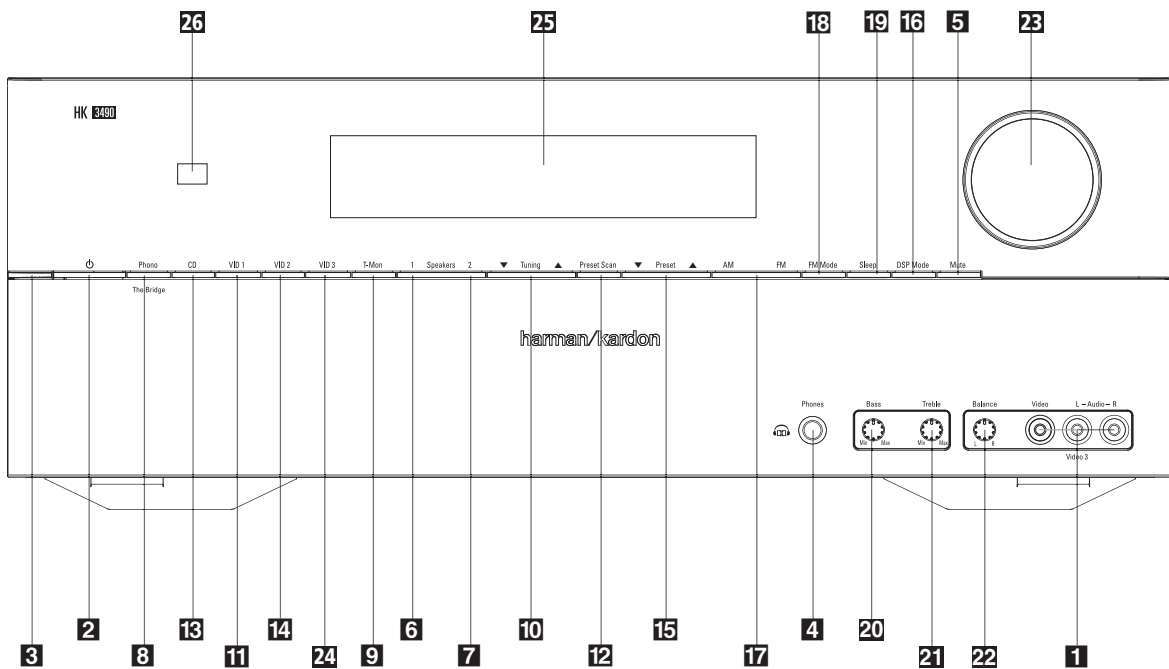

- 1** Video 3 input jacks
- 2** System Power Control
- 3** Power Indicator
- 4** Headphone Jack
- 5** Mute
- 6** Speaker 1 Selector
- 7** Speaker 2 Selector
- 8** Phone Input Selector
(The Bridge/Phono Input Selector HK 3490 only)
- 9** Tape Monitor Input Selector
- 10** Tuning Button
- 11** Video 1 Input Selector
- 12** Preset Scan
- 13** CD Input Selector
- 14** Video 2 Input Selector
- 15** Preset Selector
- 16** DSP Function Selector (HK 3490 only),
Dimmer Switch (HK 3390 only).
- 17** FM/AM Selector
- 18** FM Mode Selector
- 19** Sleep Button
- 20** Bass Control
- 21** Treble Control
- 22** Balance Control
- 23** Volume Control
- 24** Video 3 Input Selector
- 25** Information Display
- 26** Remote Sensor Window

1 Video 3 Input Jacks: These audio/video jacks may be used for temporary connection to video games or portable audio/video products such as camcorders and portable audio players.

To select the front-panel inputs, press the **Video 3 Input Selector 24** repeatedly until the Information Display shows the text "VIDEO F / ANALOG". When using the rear panel inputs, the Display shows "VIDEO 3 / ANALOG".

2 System Power Control: When the **Main Power Switch 29** is "ON," press this button to turn on the HK 3490/HK 3390; press it again to turn the unit off (to Standby). Note that the **Power Indicator 3** changes color from amber to white when the unit is on.

3 Power Indicator: This LED will illuminate in amber when the unit is in the Standby mode to signal that the unit is ready to be turned on. When the unit is in operation, the indicator will turn white.

4 Headphone Jack: This jack may be used to listen to the HK 3490/HK 3390's output through a pair of headphones. Be certain that the headphones have a standard 6,3 mm stereo phone plug. When a headphone is connected, the Speakers 1 and Speakers 2 Selectors are inactive.

5 Mute: Press this button to momentarily silence the speaker and preamp output of the HK 3490/HK 3390.

6 Speakers 1 Selector: Press this button to turn the speakers connected to the **Speaker 1** output terminals **17** on or off.

7 Speakers 2 Selector: Press this button to turn the speakers connected to the **Speaker 2** output terminals **18** on or off.

Front Panel Controls

8 Phono / The Bridge Input Selector: Press this button to select the output of a turntable that is connected to the **Phono** inputs **6**.

HK 3490 only: This button also selects "The Bridge" iPod player from Harman Kardon (The Bridge is not included with the receiver), if connected to the special input **22** on the rear panel. Press this button repeatedly to toggle between Phono and The Bridge. When The Bridge is selected, the Information Display shows "DMP" for Digital Music Player. If no Bridge is connected, the word "UNPLUGGED" appears after a few seconds to indicate that no Bridge unit has been detected.

9 T-Mon Input Selector: Press this button to listen to the output of a tape recorder connected to the **Tape Monitor** inputs **9**. T-MON is shown on the Information Display to indicate that the input source is being monitored when the HK 3490/HK 3390 is connected to a three-head tape deck or another unit with off-head playback.

Note, that when **TAPE M.** is selected the tape-deck's signal will be audible in your speakers but the previously selected input source remains routed to the **Tape Record Outs 10**. Press the button again to hear the previously selected input source directly again.

10 Tuning Button: Press the left side of the button to tune lower frequency stations and the right side of the button to tune higher frequency stations. When a station with a strong signal is tuned, the **TUNED** indicator will illuminate in the **Information Display 25**. A brief press of the button will manually tune to the next frequency increment, while pressing and holding the button for a longer period (>0.5 sec) will step quickly through the frequencies. As soon as the button is released the unit will automatically tune to the next station with a signal strong enough for acceptable reception.

11 Video 1 Input Selector: Press this button to listen to and/or view the output of a device connected to the **Video 1 Inputs 8**.

12 Preset Scan: Press this button to automatically scan through the stations that have been programmed in the HK 3490/HK 3390's memory. The tuner will play five seconds of each station before moving to the next preset station. To stop the scan when the desired station is heard, press the button again. (See page 13 for more information on the tuner memory system.)

13 CD Input Selector: Press this button to listen to the output of a CD player connected to the **CD** inputs **7**.

14 Video 2 Input Selector: Press this button to listen to and/or view the output of a device connected to the **Video 2 Inputs 12**.

15 Preset Selector: Press this button to step up or down through the list of stations that has been entered into the preset memory. (See page 13 for more information on tuner programming.)

16 DSP (Digital Sound Processor) Mode (HK 3490 only): This Button activates the Dolby Virtual Surround function. Press the button repeatedly to toggle between STEREO, DVS-WIDE and DVS-REFE. See page 12 for explanation of DVS.

HK 3390 only: Dimmer Switch. Press this button to dim the display and switch off the light inside the Volume Button. On the HK 3490, this is done from the Remote Control, button **H**.

17 FM/AM Selector: Press this button to select the tuner as the input to the receiver. When the tuner is in use, press this button to change between the AM and FM frequency bands.

Note: When an RDS station is tuned, the FM button has the same function as the RDS Display button on the remote control. Press to cycle through the various RDS displays (see page 14).

18 FM Mode Selector: Press this button to select the stereo or mono mode for FM tuning. In the STEREO mode, the word STEREO will illuminate in the **Information Display 25**, and stereo reception will be provided when stations are transmitting stereo signals. In the MONO mode, the left and right signals from stereo broadcasts will be mixed together and reproduced through all channels. Select MONO for better reception of weak signals.

19 Sleep Button: Press this button to place the unit in the Sleep mode. Each press of the button selects the amount of time that will remain before the unit automatically goes into the Standby mode, as shown in the **Information Display 25**, in the following order:

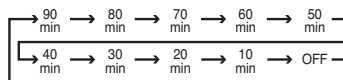

20 Bass Control: Turn this control to modify the low-frequency output of the left/right channels by as much as ± 10 dB. Set this control to a suitable position for your taste and room acoustics. The button is recessed. To use the button, push it in, and it will pop out for easy operation when you let it go. Push it back in after use.

21 Treble Control: Turn this control to modify the high-frequency output of the left/right channels by as much as ± 10 dB. Set this control to a suitable position for your taste and room acoustics. The button is recessed. To use the button, push it in, and it will pop out for easy operation when you let it go. Push it back in after use.

22 Balance Control: Turn this control to change the relative volume for the front left/right channels. The button is recessed. To use the button, push it in, and it will pop out for easy operation when you let it go. Push it back in after use.

23 Volume Control: Turn the knob clockwise to increase volume, counterclockwise to decrease the volume.

24 Video 3 Input Selector: Press this button to listen to and/or view the output of a device connected to the **Video 3 Inputs 14 1** on either the front or rear panel. If devices are connected to both the front- and rear-panel **Video 3 Inputs 14 1**, then the device connected to the rear-panel **Video 3 Inputs 14** will be selected first, as indicated by the **Video 3** being shown in the display. To select the device connected to the front-panel **Video 3 Inputs 1**, press the **Video 3 Input Selector 24** again so that the display reads "Video F". Each subsequent press of the **Video 3 Input Selector 24** will toggle between the front and rear **Video 3 Inputs 14 1**.

25 Information Display: This display delivers messages and status indications to help you operate the receiver. In case of short circuits in the speaker cables or other malfunctions, a warning text appears in the display, indicating type of error. There is no sound until the malfunction is corrected.

26 Remote Sensor Window: The sensor behind this window receives infrared signals from the remote control. Aim the remote at this area and do not block or cover it unless an external remote sensor is installed.

Rear Panel Connections

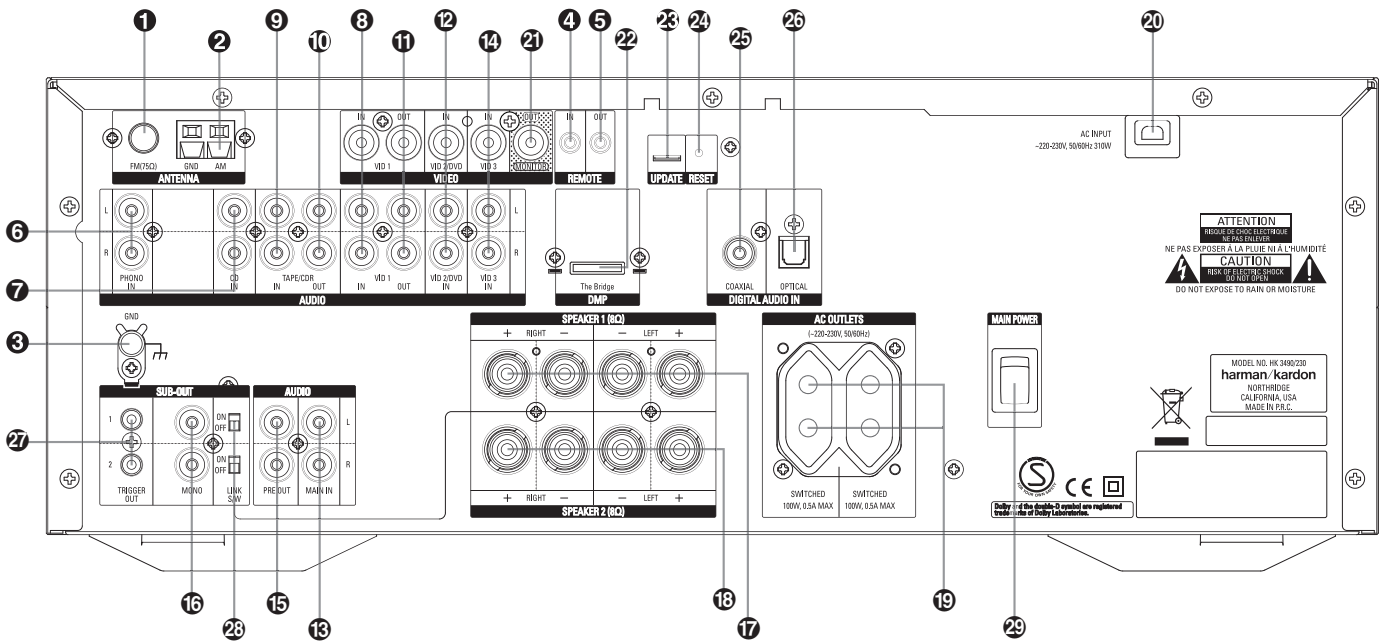

- | | | |
|---|---|--|
| <ul style="list-style-type: none"> 1 FM Antenna 2 AM Antenna 3 Phono Ground 4 Remote IR In 5 Remote IR Out 6 Phono Inputs 7 CD Inputs 8 Video 1 Audio/Video Play/In 9 Tape Monitor Play/In 10 Tape Monitor Record/Out | <ul style="list-style-type: none"> 11 Video 1 Audio/Video Record/Out 12 Video 2 Audio/Video Inputs 13 Main In 14 Video 3 Audio/Video Inputs 15 Preamp Out 16 Subwoofer Out 17 Speaker 1 Terminals 18 Speaker 2 Terminals 19 Switched AC Outlet 20 Power Cable | <ul style="list-style-type: none"> 21 Video Monitor Outputs 22 The Bridge Input (HK 3490 only) 23 Update Cable Input 24 Reset Switch 25 Coaxial Digital Audio Input (HK 3490 only) 26 Optical Digital Audio Input (HK 3490 only) 27 Subwoofer Trigger Outputs 28 Subwoofer Link On/Off Switches 29 Main On/Off Switch |
|---|---|--|

Rear Panel Connections

1 FM Antenna: Connect an indoor or external FM antenna to this terminal.

2 AM Antenna: Connect the AM loop antenna supplied with the receiver to these terminals. If an external AM antenna is used, make connections to the **AM** and **GND** terminals in accordance with the instructions supplied with the antenna.

3 Phono Ground: Connect the ground wire from a turntable to this terminal to reduce system hum.

4 Remote IR In: If the HK 3490/HK 3390's front panel IR sensor is blocked due to cabinet doors or other obstructions, an external IR sensor may be used. Connect the output of the sensor to this jack.

5 Remote IR Out: This connection permits the IR sensor in the receiver to serve other remote controlled devices. Connect this jack to the "IR IN" jack on Harman Kardon or other compatible equipment.

6 Phono Inputs: Connect the outputs of your turntable or tone arm to these jacks. Note that only Moving Magnet (MM) type cartridges may be used. High Output Moving Coil types may be used, but the level may be low. Low Output MC types are dependent on an additional MC step-up transformer or Head-Amp before they can be used.

7 CD Inputs: Connect these jacks to the output of a compact disc player or CD changer.

8 Video 1 Audio/Video Play/In: Connect these jacks to the PLAY/OUT jacks of an audio or video device, such as a VCR or DVD player. In order to view the video signal of a video device connected to this input, remember to connect the **Video Monitor Output 21** to the video input of your TV or video display.

9 Tape Monitor Play/In: Connect these jacks to the Play/Out jacks of an audio recorder.

10 Tape Monitor Record/Out: Connect these jacks to the Rec/In jacks of an audio recorder.

NOTE: When these jacks are connected to a three-head recorder or another device with off-head playback, it will be possible to monitor the recorded sound directly from the tape.

11 Video 1 Audio/Video Record/Out: Connect these jacks to the Rec/In jacks of an audio or video recorder.

12 Video 2 Audio/Video Inputs: Connect these jacks to the PLAY/OUT jacks of an audio or video device, such as a VCR or DVD player. In order to view the video signal of a video device connected to this input, remember to connect the **Video Monitor Output 21** to the video input of your TV or video display.

13 Main In: These jacks are the input to the HK 3490/HK 3390's power amplifier. Unless an external pre-amplifier is used, the jumper pins should remain connected to the **Preamp Out** jacks 15.

14 Video 3 Audio/Video Inputs: Connect these jacks to the PLAY/OUT jacks of an audio or video device, such as a VCR or DVD player. In order to view the video signal of a video device connected to this input, remember to connect the **Video Monitor Output 21** to the video input of your TV or video display.

15 Preamp Out: These jacks provide an output for the left and right channels to an optional external amplifier. In normal operation, unless an external power amplifier is used, the jumper pins should remain connected to the **Main In** jacks 13.

16 Subwoofer Out: Connect these jacks to the line-level input of a powered subwoofer. If an external subwoofer amplifier is used, connect this jack to the subwoofer amplifier input. When a single, mono subwoofer is used, make the connection to the bottom jack.

17 Speaker 1 Terminals: Connect these terminals to the appropriate terminals on your speakers.



18 Speaker 2 Terminals: Connect these terminals to the appropriate terminals on your speakers.

19 Switched AC Outlet: These outlets may be used to power low-current draw devices such as CD players or cassette decks. The power to these outlets remains on as long as the receiver itself is on. When the receiver is turned off, or placed in the Standby mode, power to these outlets is removed.

NOTE: The power consumption of the devices plugged into each of these outlets should not exceed 100 watts.

20 Power Cable: Connect the AC plug to a nonswitched AC wall output.

21 Video Monitor Output: Connect this jack to the composite video input of your TV or video display device. Doing so will enable you to view the video signal of a properly connected video source device, when that source input is selected. When an audio-only source is selected, the **Video Monitor Output 21** will not transmit video signal.

22 The Bridge Input (3490 only):  **Digital Media Player (DMP) Connector:** With the HK 3490 turned off, connect one end of the optional Harman Kardon  cable to this proprietary connector. When the Digital Media Player source is selected, you may view your iPod's control and navigation messages on the Information Display. You may navigate the

iPod and select tracks for playback using the **▲/▼/◀/▶ Buttons F**, the **OK Button X** and **Transport Controls D E T** on your receiver's remote. See page 14 for more information.

23 and 24 Update Cable Input and Reset Switch: This specialized connector may be used with your personal computer in case Harman Kardon offers a software upgrade for the receiver at some time in the future. At the time of writing, this connector should only be used by Harman Kardon service centers. The Reset Button is only used during a software upgrade.

25 Coaxial Digital Input (3490 only): Connect the coax digital output from a DVD player, HDTV receiver, the output of a compatible computer sound card playing MP3 files or streams, LD player, MD player or CD player to this input. The signal must be a standard PCM digital source. Do not connect the RF digital output of an LD player to these jacks.

26 Optical Digital Input (3490 only): Connect the optical digital output from a DVD player, HDTV receiver, the output of a compatible computer sound card playing MP3 files or streams, LD player, MD player or CD player to this input. The signal must be a standard PCM digital source.

27 Subwoofer Trigger Outputs: Connect one of these 3.5mm jacks to the trigger input on your subwoofer (if so equipped) to switch the subwoofer on and off from the 3490/3390 receiver. As there are two trigger outputs, you can control two subwoofers separately, for example in two rooms.

28 Subwoofer Link On/Off Switches: These switches control whether or not a subwoofer connected to the Trigger Outputs 27 switches on and off following your selection of loudspeaker set 1 or 2. If you set the switch to ON, the subwoofer controlled by the Trigger Output belonging to the switch will be switched ON when you select the Loudspeaker set with the same number. If you select the Speaker set OFF, the subwoofer shuts off as well. Setting the switch to OFF interrupts the Link function, and the subwoofer will be ON as long as the 3490/3390 is on.

29 Main On/Off Switch: When switched ON, the unit is placed in Stand-by mode, indicated by the Power Indicator **3** lighting up in amber color. To listen to the amplifier, press the Power ON Button **A** on the Remote Control or the System Power Control **2** on the front panel of the amplifier.

Remote Control Functions

- A** Main Power On
- B** Main Power Off
- C** Source Selectors (The Bridge only on HK 3490)
- D** Preset Up/Down
- E** Transport Controls
- F** Menu Navigation **▼▲◀▶**
- G** Sleep Button
- H** Dimmer Button
- I** Main Tuning Buttons
- J** Direct Button
- K** Numeric Keys
- L** Auto Preset
- M** Menu Button
- N** Clear Button
- O** Memory Button
- P** Master Volume
- Q** P. Scan Button
- R** Mute Button
- S** FM Mode Button
- T** Search Forward / Search Reverse Button
- U** Speaker 1 Selector
- V** Speaker 2 Selector
- W** Transmitter Window
- X** OK Button
- Y** RDS Display Button
- Z** RDS PTY Button
- AA** DSP Mode Button (Only on HK 3490)
- BB** Disc Menu Button

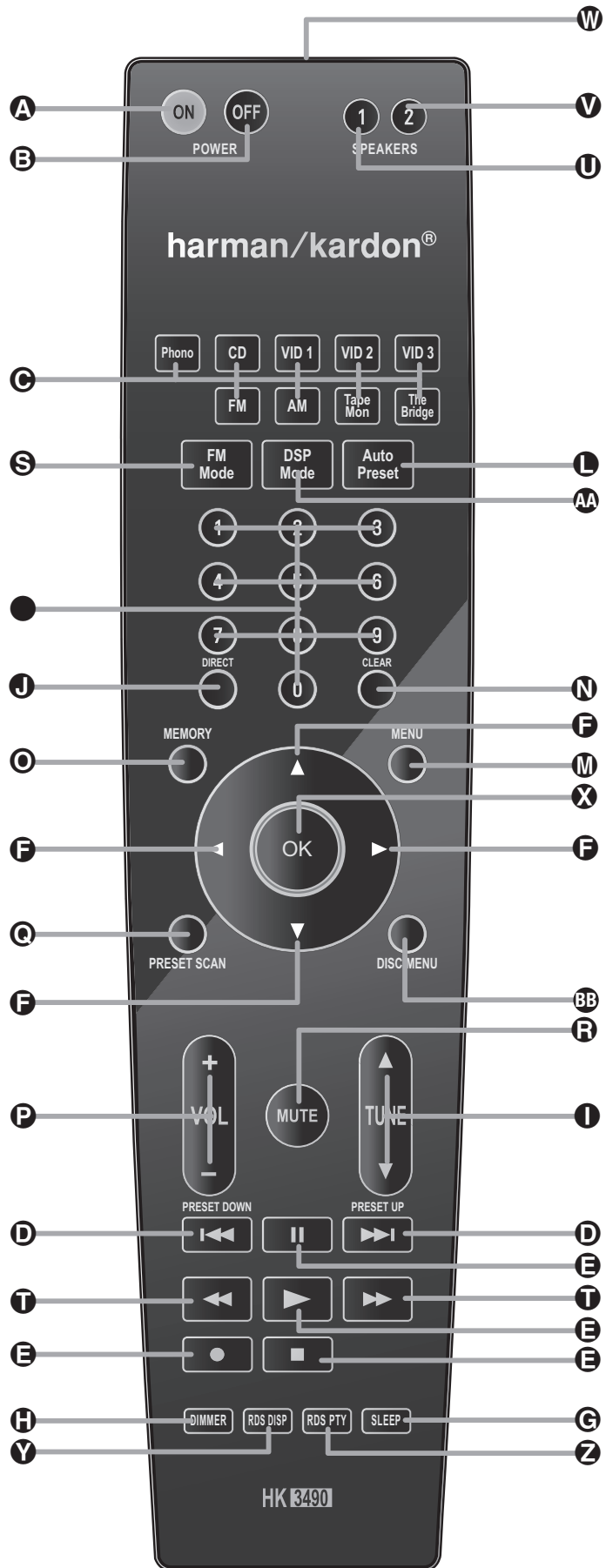

Remote Control Functions

The remote is capable of operating the HK 3490/ HK 3390 and most Harman Kardon CD changers or players, CD Recorders and Tape decks, using the control codes that are part of the remote.

A Main Power On: When the HK 3490/ HK 3390 is in the Standby mode, as indicated by the **Power Indicator** **3** glowing amber, press this button to turn the HK 3490/ HK 3390 on.

B Main Power Off: When the HK 3490/ HK 3390 is turned on, press this button to place it in the Standby mode. Note that in this condition, the unit is still connected to AC Power.

C Source Selectors: Press these buttons to select an input source for the HK 3490/ HK 3390.

NOTE: The first press of the **Video 3 Source Selector** **14** will select the device connected to the rear-panel **Video 3 Audio/Video Inputs** **14**. Press the **Video 3 Source Selector** **14** again until the display reads VIDEO F / ANALOG to select the device connected to the front-panel **Video 3 Audio/Video Inputs** **1**. Each additional press of the **Video 3 Source Selector** **14** will toggle between the front- and rear-panel **Video 3 Audio/Video Inputs** **14**.

D Preset Up/Down: When the tuner is in use, these buttons scroll through the stations that have been programmed into the HK 3490/ HK 3390's memory. These buttons also control the track Skip Up and Down on compatible Harman Kardon compact disc players/changers, CD-Recorders and cassette decks (with that function).

E Transport Controls: These buttons are used to control Play, Play Forward, Play Reverse, Stop, Pause and Record functions on compatible Harman Kardon compact disc players/changers and cassette tape decks. Also, when a compatible Harman Kardon compact disc player or changer, or cassette deck, has been selected using the **Source Selectors** **14**, additional transport control functions are available using the **Preset Up/Down** **D** buttons.

F Menu Navigation Buttons: Use these buttons to move Up, Down, Left or Right when using the Menu system of the HK 3490/ HK 3390.

G Sleep Button: Press this button to place the unit in the Sleep mode. Each press of the button selects the amount of time that will remain before the unit will automatically go into the Standby mode, as shown in the **Main Information Display** **25**, in the following order:

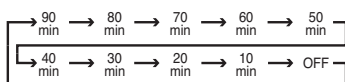

Holding the button pressed for some seconds will directly turn off the Sleep time selection.

H Dimmer Button: Press this button once to reduce the brightness of the front panel display to half the normal intensity and turn off the light inside the Volume Button. Press it again to turn the front panel display completely off. When the display is completely off, press the button to return to normal brightness.

I Main Tuning Buttons: When the tuner is in use, these buttons will tune up or down through the selected frequency band. A brief press of the button will manually tune to the next frequency increment, while pressing and holding the button for a longer period (>0.5 sec) will step quickly through the frequencies. As soon as the button is released the unit will automatically tune to the next station with a signal strong enough for acceptable reception.

J Direct Button: Press this button to select a radio station by entering its frequency using the **Numeric Keys**. (See page 13 for more information.)

K Numeric Keys: These buttons serve as a ten-button numeric keypad to enter tuner preset positions or track numbers with CD players/changers or to tune stations directly.

L Auto Preset: When the tuner and FM band have been selected, this button may be used to automatically program the tuner presets for all stations with acceptable signal strength. To start the auto preset scan, press and hold the button. Keep holding the button pressed until the tuner will start to "look" for stations, as shown by increasing frequency numbers in the Information Display. Release the button and note that the tuner will search the entire FM band and stop briefly at each station that has acceptable signal strength. The HK 3490/ HK 3390 will automatically assign a preset number to each station and then search for the next station. If the FM tuner finds fewer than 30 FM stations with acceptable signal strength, the Auto Preset tuning will scan two more cycles or until the remaining vacant preset memory spaces have been filled with those found in the first scan. The scan will stop when all 30 preset memory spaces have been filled or when three scans through the band have been completed (See page 13 for more information).

M Menu Button: When using a H/K DVD player with the receiver, you can activate the DVD Menu with this button.

N Clear Button: This button is used to clear preset memory information for the HK 3490/ HK 3390's tuner. (See page 13 for more information on tuner presets.)

O Memory Button: Press this button to open a memory position that stores a preset location for the HK 3490/ HK 3390's tuner. (See page 13 for more information on tuner presets.)

P Master Volume: Press these buttons to raise or lower the HK 3490/ HK 3390's volume.

Q P. Scan Button: Press this button to automatically scan through the list of stations that are programmed into the HK 3490/ HK 3390's tuner memory. When the button is pressed, each preset station will play for five seconds before the next station is selected. Press the button again when the desired station is heard to stop the preset scan.

R Mute Button: Press this button to momentarily silence the HK 3490/ HK 3390.

S FM Mode Button: Press this button when the tuner is in use in the FM band to switch to monaural reception if the stereo station is weak and noisy. (See page 12 for more information.)

T Search Forward / Search Reverse Buttons: When using a H/K CD-player or DVD-player, use these buttons to fast search in either direction.

U Speaker 1 Selector: Press this button to turn the speakers connected to the **Speaker 1 Output** terminals **17** on or off.

V Speaker 2 Selector: Press this button to turn the speakers connected to the **Speaker 2 Output** terminals **18** on or off.

W Transmitter Window: Point this area of the remote toward the receiver when using the remote.

X OK Button: This button has no function on the HK 3490/ HK 3390, but may be used as the Enter key for a compatible Harman Kardon DVD Player or as the Random Play button for a compatible CD Player. (See page 16 for more information on using the remote to control other devices.)

Y RDS Display Button: Press this button to view the various displays of the RDS options that are available when a station is transmitting RDS data. (See page 14 for more information on RDS tuning.)

Z RDS PTY Button: Press this button to start a search for a specific PTY type using the RDS capabilities of the HK 3490/ HK 3390. (See page 14 for more information on RDS tuning.)

AA DSP Mode Button. (HK 3490 only): This Button switches between the Digital Sound Processor Modes. Press to activate the Dolby Virtual Surround function. Press repeatedly to toggle between STEREO, Dolby Virtual Surround-WIDE and Dolby Virtual Surround-REF. See page 12 for explanation of DVS.

BB Disc Menu Button: Displays the actual DVD Disc Menu on the TV screen in Play Mode.

Installation and Connections

Audio and Speaker Connections

After unpacking the unit and placing it on a solid surface capable of supporting its weight, you will need to make the connections to your audio and video equipment. These steps need to be done only when the receiver is first installed or when a change is made to the input source equipment.

Audio Equipment Connections

We recommend that you use high-quality interconnect cables when making connections to source equipment and recorders to preserve the quality of the signals.

When making connections to audio source equipment or speakers it is always a good practice to unplug the unit from the AC wall outlet. This prevents any possibility of accidentally sending audio or transient signals to the speakers that may damage them.

1. Connect the analog output of a CD player to the **CD** inputs **7**.

NOTE: When the CD player has both fixed and variable audio outputs, it is best to use the fixed output unless you find that the input to the receiver is so low that the sound is noisy, or so high that the signal is distorted.

2. Connect the Play/Out jacks of a cassette deck, CDR, MD or other audio recorder to the **Tape Monitor Play** jacks **9**. Connect the Record/In jacks on the recorder to the **Tape Monitor Rec. Out** jacks **10** on the HK 3490/HK 3390. When the tape deck connected to these jacks is a three-head unit or has off-head playback, it will be possible to monitor the output of the source being recorded.

3. Connect the audio and/or video outputs of a second audio recorder, VCR or other line-level audio device to the **Video 1 Audio/Video Input Jacks 8**. If a recorder is used, connect its Rec/In jacks to the matching outputs **11**.

4. The audio output of any electronics product with a line-level output, such as a TV set, satellite receiver or DVD, may be connected to the **Video 2** and **Video 3 Audio/Video inputs 12/14**.

NOTE: In order to view the video signals of any devices connected to the **Video 1 6**, **Video 2 12** or **Video 3 14 Video Inputs**, you will need to connect the **Video Monitor Output 21** jack to the composite video input of your TV or other video display device.

5. Connect the outputs of a turntable with a moving magnet cartridge to the **Phono** inputs **6**. To insure that the phono playback is noise-free, connect the ground wire from the tone-arm to the **Phono Ground** terminal **3**.

6. Assemble the AM Loop Antenna supplied with the unit as shown below. Connect it to the **AM** spring loaded terminals **2**.

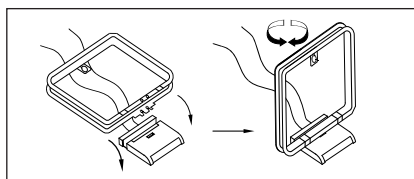

7. Connect an FM antenna to the **FM Antenna** connection **1**. The FM antenna may be an external roof antenna, an inside powered or wire lead antenna or a connection from a cable system. Note that if the antenna or connection uses 300-ohm twin-lead cable, you must use the 300-ohm-to-75-ohm adapter supplied with the unit to make the connection.

8. If you wish to use external processing equipment, such as an equalizer, you may connect the device to the preamp-out and main-in jacks by removing the **Preamp-Out/Main-In Jumper Pins** that connect the **Preamp Out 15** jacks to the **Main In 13** jacks, and inserting the external device, Preamp Out to the inputs of the external device and the outputs of the device to the Main Input.

Alternatively, you may connect the external device to the Tape Monitor Loop. Connect the **Tape Monitor Record/Out** jacks **10** to the inputs of the external device, and connect the outputs of the device to the **Tape Monitor Play/In** jacks **9**.

9. HK 3490 is equipped with a digital/analog converter, permitting you to connect any digital music player (CD player, MP3, Mini-Disc) that outputs a PCM digital signal for superior sound quality. Also, a DVD player may be connected for first rate stereo or Virtual Dolby Surround movie sound, provided that you set the DVD player's setup menu to always send out PCM-format from the digital outputs.

You have two input options, **Coaxial digital In 25** and **Optical digital In (TosLink) 26**. You can choose freely, and you may use both inputs simultaneously. See page 12 for explanation of how to select the Digital Inputs for listening.

10. (HK 3490 only). With the HK 3490 turned off, connect the optional Harman Kardon **Bridge to Bridge Digital Media Player (DMP) Connector 22**. Your compatible Apple® iPod® may be docked in **Bridge** when you wish to use it as your audio source device. Video materials stored on the iPod cannot to be viewed using the HK 3490.

Speaker and Output Connections

Regardless of the brand of cable selected, we recommend that you use a cable constructed of fine, multistrand copper with an area of min. 2 mm².

Cable with 1.5 mm² may be used for short runs of less than 3 meters. We do not recommend that you use cables with an area of 0.8 mm² or smaller due to the power loss and degradation in performance that will occur.

Questions about running cables inside walls should be referred to an installer or a licensed electrical contractor who is familiar with applicable local building codes in your area.

When connecting wires to the speakers, be certain to observe proper polarity. Remember to connect the "negative" or "black" wire to the black minus terminals on the receiver and the speaker. The "plus" or "red" wire should be connected from the red plus-terminal on the receiver to the "red" plus-terminal on the right speaker and the white plus-terminal on the receiver to the "red" plus-terminal on the left speaker.

We also recommend that the length of cable used to connect speaker pairs be identical. For example, use the same length piece of cable to connect the Speaker 1 left and right or Speaker 2 left and right speakers, even if the speakers are a different distance from the HK 3490/HK 3390.

NOTE: To assure proper phase, and optimal performance, consult the identification plate on your speaker, or the speaker's manual to verify polarity.

If you do not know the polarity of your speaker, assure that both speakers are connected with the same polarity, i.e. speaker wires or terminals with any marking should be connected to the red terminals on the speakers speaker terminals on the HK 3490/HK 3390, the others to the black ones (see connections below).

Connect the speakers using the following steps:

1. Connect the main speakers to the **Speaker 1** terminals **17**.

2. Connect a second set of speakers, or speakers that are in a second room location, to the **Speaker 2** terminals **18**.

3. When an optional, powered subwoofer (not the active Sub of a Sub/Sat-System) is used, connect the outputs of the mono **Subwoofer Out** jacks **16** to the line-level input of the subwoofer. If the subwoofer has no single line input, and if you cannot obtain sufficient woofer level using only one of the two inputs, use an optional Y-splitter to separate the sub mono signal from the receiver into two channels for the two inputs on the subwoofer. When a separate passive subwoofer is used, these connections will be made to the optional amplifier that powers the subwoofer.

If a Sub/Sat system is used (active or passive), connect the **Speaker 1** terminals **17** to the

Installation and Connections

speaker-level inputs on the subwoofer, and then connect the speaker-level outputs on the subwoofer to your main left and right speakers, following the instructions provided with the subwoofer.

If your subwoofer can be switched on and off with a trigger signal from the receiver, connect either of the two **Trigger Out** mini-jacks ② to the subwoofer's Trigger Input with a suitable cable, which usually comes with the subwoofer, or may be purchased separately. This means that the subwoofer (which is otherwise usually switched on and off automatically by an internal signal sensor) stays on as long as you listen to music or movie sound. Even if no deep bass is present in the signal for a while, the subwoofer does not go into standby mode when it is controlled by the trigger signal. Otherwise, when controlled by a bass signal sensor, you may not experience the first bass impulse when bass returns, after the subwoofer has gone into standby mode, because it has to switch on first.

This means that you may have a Speaker system 1 and a Speaker system 2 in two different rooms, each with its own active subwoofer that switches on when you select Speakers 1 or Speakers 2. You may also have two active subwoofers in one room, one that is always working with your main Speaker 1 set of speakers, the other to be switched on or off according to your taste if connected to the Sub Out linked to Speaker 2, without any speakers being connected to the Speaker 2 terminals. This makes it easy to add a second subwoofer only when watching movies, where extra bass level may be desirable. Set the uppermost LINK S/W ON/OFF switch that controls the Trigger Out voltage for Speaker Set 1 to ON if you want this subwoofer to switch on ONLY when you select Speaker Set 1. Set the switch OFF if you want the subwoofer to always receive the Trigger Out ON voltage and therefore be switched ON always, even if you select Speaker Set 1 to be OFF.

Repeat for the lowermost switch if you have two subwoofers or wish to switch your single subwoofer ON and OFF separately with the Speaker set 2 switch.

If your subwoofer is not equipped with a Trigger Voltage input, the position of these two switches is irrelevant.

System and Power Connections

Your Harman Kardon receiver is designed for flexible use with external control components and power amplifiers. These connections are easy to make during an initial installation, or at a later date should you choose to upgrade your system.

Remote Control Extension

If the receiver is placed behind a solid or smoked glass cabinet door, the obstruction may prevent the remote sensor from receiving commands. In this event, an optional remote sensor may be used. Connect the output of the remote sensor to the **Remote IR In** jack ④.

If other components are also prevented from receiving remote commands, only one sensor is needed. They may use this unit's sensor or a remote eye by running a connection from the **Remote IR Out** jack ⑤ to the Remote In jack on Harman Kardon or other compatible equipment.

External Audio Power Amplifier Connections

If desired, an optional, external amplifier may be used in place of the HK 3490/HK 3390's internal power amplifier.

To connect an external power amplifier, first remove the **Pre-Out/Main-In Jumper Pins** ⑭ that connect the **Preamp Out** ⑮ and **Main In** ⑬ jacks on the rear panel. Keep the jumpers in a safe place should they be needed at a later time.

Using high-quality audio interconnect cables, connect the **Preamp Out** jacks ⑮ to the input jacks on your power amplifier. Make certain to match the right output to the right input and the left output to the left input.

Note that when an external power amplifier is used, no special adjustments are required. All volume and other control adjustments are made using the standard front panel or remote controls.

AC Power Connections

This unit is equipped with two accessory AC outlets. They may be used to power accessory devices, but it should not be used with high-current draw equipment such as power amplifiers. The total power draw may not exceed 100W for each outlet.

This **Switched AC Outlets** ⑲ will receive power only when the unit is on. This is recommended for devices that have no power switch, or those with a mechanical power switch that may be left in the "ON" position.

NOTE: Devices with electronic power switches may only go into a Standby mode when plugged in here.

Speaker Placement

For optimal listening enjoyment, and for sound-field reproduction that best re-creates the original recording, it is good practice to place the speakers so that they form a triangle with the speakers at the front of the room, and the preferred listening spot at the third point of the triangle. The distance between each speaker and the listener should be identical.

For example, if the speakers are 2,5 meters from one another, each of the speakers should optimally be placed so that they are also 2,5 meters from the listener. It is also desirable to place speakers so that their tweeters, or highfrequency drivers, are aimed at ear height when you are seated in the listening position.

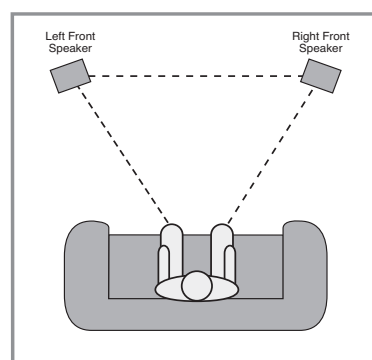

A good starting point for speaker placement is to make the distance between the two speakers and the distance between either speaker and the listener identical.

To optimize the sound field, or to suit your listening room environment, you may find that some experimentation is required to find the correct location. Ideally, pans from left to right across the front of the room should sound smooth, and instruments should appear to be coming from the proper location within an orchestra.

The placement of subwoofers should be done as suggested in the manufacturer's instructions. In general, subwoofers often produce best results when they are placed in the corner of a room, along the same wall as the speakers, but optimal placement will vary widely depending on room size, the subwoofer type and the placement of rugs and furniture in a room. It may be helpful to temporarily position the subwoofer in the usual listening position, then walk around the room while program material is playing until the bass reproduction sounds best to your ears. That location is likely to be the optimum position for the subwoofer.

Finally, when all connections are complete, plug the power cord into a nonswitched 230-volt AC wall outlet. You're ready to enjoy the HK 3490/HK 3390!

Operation

Basic Operation

The HK 3490/HK 3390 is simple to operate, and very similar to stereo receivers you may have used in the past. This section will explain the use of several features that may be new to you.

- Install the four supplied AAA batteries in the remote as shown. Be certain to observe the (+) and (-) polarity indicators shown in the bottom of the battery compartment.

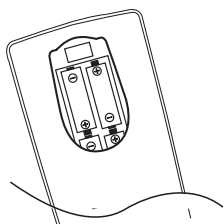

- When using the HK 3490/HK 3390 for the first time, the unit will be in a standby mode, as indicated by the amber color of the **Power Indicator 3**. Once the unit is in standby, you may begin a listening session by pressing the **System Power Control 2** on the front panel or the **Main Power On** button **A** on the remote. Note that the **Power Indicator 3** will turn white. This will turn the unit on and return it to the input source that was last used. The unit may also be turned on from standby by pressing any of the **Source Selector** buttons on the front panel **8 9 11 13 14 17 24** or remote **C**.

To turn the unit off at the end of a listening session simply press the **System Power Control 2** on the front panel or the **Main Power Off** button **B** on the remote. This places the unit in the Standby mode, and the **Power Indicator 3** will turn amber to remind you that the unit is ready for operation when a power command is received from the remote.

Power to any equipment plugged into the rear panel **Switched AC Outlet 19** will be shut off. When the remote is used to turn the unit "off", it is actually placing the system in a standby mode, as indicated by the amber color of the **Power Indicator 3**.

- To dim the brightness of the front panel display, press the **Dimmer** button **H** on the remote or on the front panel **16** (HK 3390 only). The first press will dim the lights to half normal and turn the light inside the volume button off. A second press will turn the display completely off. Press the **Dimmer** button **H/16** again to restore the display to normal brightness. If you press any button on the remote control or front panel, the display and volume button light up for a few seconds, then dim again.

Source Selection

- To select a source at any time, press any of the **Source Selector** buttons on the remote **C** or front panel **8 9 11 13 14 17 24**.

Selection of Digital Sources

The Digital Inputs **25 26** have no separate Input Selector Buttons. Instead, you can link each of the other inputs (Phono, CD, Vid 1-2-3) to one of the Digital Inputs, or let it have its basic analog function.

To Select a Digital Input, press and hold the normal Input Selector Button **8 13 11 14 24** on the front panel of the receiver that you wish to associate with the Digital Input. While holding this button in, repeatedly press the T-MON **9** Button. As you can now see in the Display, the input function cycles between Optical, Coaxial and Analog. Release both buttons when you have the result you want. Example: you want to have your CD player's Digital signal converted to Analog in the receiver, and you are using a Coaxial cable from the CD player's digital output to the receiver's Digital Input **25**. Press and hold the CD Button **13** on the front panel, push the T-MON **9** until the word COAXIAL appears in the receiver's Display, and release both buttons. Now, every time you select CD on the receiver, the signal will be taken from the Coaxial Digital Input. This is also possible for the Phono Input, in case you do not use a Record Player/Turntable, but of course you cannot process an analog record player signal through the digital inputs. However, as soon as you select the Phono Input to process a digital signal, the special amplification and frequency compensation that is a normal part of analog record playback is no longer in effect.

To return to analog signal, simply repeat the select procedure, but release both buttons when the Display shows ANALOG.

- When a video source is selected, if you have connected a video device to the video input jack for that source, and if you have connected the **Video Monitor Output 21** to the composite video input of your TV or video display, you will be able to enjoy video programs from a broadcast, cable or satellite television system; a VCR or hard-disk video recorder; a DVD player; or any other video device with analog line-level audio outputs and a composite video output.

NOTE: Although the HK 3490/HK 3390 is an audio/video receiver, it is not a surround sound receiver. Audio will be played in two-channel stereo, Virtual Dolby Surround (only HK 3490) or monaural, depending on how the program material is encoded, and you will not be able to hear any additional channels that may be encoded in your source materials. You will not be able to make any digital audio connections through the HK 3490/HK 3390.

Dolby Virtual Speaker: This technology uses a next-generation advanced algorithm to reproduce the dynamics and surround sound effects of a precisely placed 5.1-channel speaker system using only front left and right speakers. In the Reference Mode, the apparent width of the sound across the front image is defined by the distance between the two speakers. The Wide Mode provides a wider, more spacious front image when the two speakers are close together.

- During a listening session you may wish to adjust the **Bass 20**, **Treble 21** and **Balance 22** controls to suit your listening tastes.

If you have used the trim covers to hide the buttons, push the end of the cover until the hidden button jumps out and presses the cover out completely or so far that you can grab hold of it for easy removal. The three buttons are spring loaded and pop in and out with each firm push, to allow for easy operation and flush appearance.

- Adjust the volume to a comfortable level using the front panel **Volume Control 23** or remote **Master Volume Up/Down P** buttons. The volume level is displayed as a negative number of decibels (dB) in the **Main Information Display 25**. The volume level is relative to a maximum volume level that has been assigned the value of 0dB. It is important that you make sure never to exceed this maximum volume level (0dB) at any time, in order to avoid possible damage to your loudspeakers due to "clipping", a type of distortion that is not audible to the human ear until it is severe enough to permanently damage most loudspeakers. It is also possible, depending upon the program material, for clipping to occur at volumes below the maximum volume level.

- To temporarily silence all speaker outputs, press the **Mute** button **R/5**. This will cut the output to all Pre and Sub Outs and to all speakers, but it will not affect any recording or dubbing that may be in progress. When the system is muted, the **MUTE** indicator will light in the **Main Information Display**. Press the **Mute** button **R/5** again to return to normal operation.

- For private listening, plug the 6,3 mm stereo phone plug from a pair of stereo headphones into the front panel **Headphone** jack **4**.

- One or two separate sets of speakers may be connected to the HK 3490/HK 3390. To listen to one of the speaker sets, press the **Speaker** button **6** or **7** on the front panel corresponding to the desired speakers or press them both to listen to both speakers pairs. The active speakers will be indicated by the Information Display showing SPK 1 or SPK 2. If both pairs are in use, SPK 1+2 is shown. Both sets of speakers may be turned off for private headphone listening.

Operation

IMPORTANT NOTE: When two speaker pairs are connected to the HK 3490/HK 3390 and are to be used simultaneously, the impedance of each speaker must not be lower than 8 Ohms.

• To program the HK 3490/HK 3390 for automatic turn-off, press the **Sleep** button on the front panel **19** or remote **G**. Each press of the button will increase the time before shutdown in the following sequence:

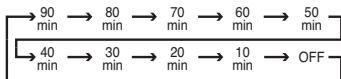

The sleep time will be displayed in the **Main Information Display 25** and it will count down until the time has elapsed.

When the programmed time has elapsed, the unit will automatically turn off (to Standby mode). Note that the front panel display will dim to one-half brightness when the Sleep function is programmed. To cancel the Sleep function, press the **Sleep** button **19 G** or simply hold it pressed for some seconds until the Sleep indicator numbers disappear and the Main Information Display shows the current source. Pressing any control button while the Sleep control is activated will momentarily return the Main Information Display to full brightness for increased legibility without interrupting the Sleep function.

Tuner Operation

The HK 3490/HK 3390's tuner is capable of tuning AM, FM and FM Stereo broadcast stations. Stations may be tuned manually or automatically, or they may be stored as favorite station presets and recalled from a 30-position memory.

Station Selection

1. Press the **AM/FM 17** buttons on the front panel or on the remote **C** to select the tuner as an input.
2. Press these buttons again at any time to switch between AM and FM.
3. To automatically search for the next higher- or lower-frequency station that has an acceptable signal hold the **Tuning** **▲** or **▼** button **10** on the front or **1** on the remote pressed and release it as soon as the tuner starts the frequency search. To tune to the next station, press the button again. Tap the **Tuning** button to advance one frequency increment at a time, or press and hold it to locate a specific station. When the **TUNED** indicator lights, the station is properly tuned and should be heard with clarity.
4. Stations may also be tuned directly by pressing the **Direct** button **1**, and then pressing the **Numeric Keys K** that correspond to the station's frequency. The desired station will automatically be tuned.

NOTE: When the FM reception of a stereo station is weak, audio quality will be increased by switching to Mono mode by pressing the **FM Mode** button **18 S** until MONO appears in the display.

Preset Tuning

Up to 30 stations may be stored in the HK 3490/HK 3390's memory for easy recall using the front panel controls or the remote. In order to program preset stations into memory, you must use the remote control.

To enter a station into the memory, first tune the station using the steps outlined above. Then:

1. Press the **Memory** button **9** on the remote. Note that the **MEMO** and **PRESET** indicators will light and flash in the Main Information Display.
2. Within five seconds, press the **Numeric Keys K** corresponding to the location where you wish to store this station's frequency. For all preset numbers above "3" the station will be stored directly. Note that for the presets 1, 2 or 3 either you press the corresponding number and wait for 5 seconds or you press a "0" before you press the 1, 2 or 3, then the station will be stored at once.
3. Repeat the process after tuning any additional stations to be preset.

Auto Preset

• Preset stations may also be programmed automatically for the entire FM band. To automatically enter each station that may be tuned with acceptable quality into the HK 3490/HK 3390's preset memories, first select the FM band. Next, press and hold the **Auto Preset** button **L** until the station frequency indication begins to increase. Release the button and note that the tuner will search the entire FM band, and stop briefly at each station that has acceptable signal strength. The HK 3490/HK 3390 will automatically assign a preset number to each station, and then search for the next station. If the FM tuner finds fewer than 30 FM stations with acceptable signal strength, the Auto Preset tuning will scan up to two more cycles until the remaining vacant preset memory spaces have been filled.

The automatic scan process will stop when all 30 preset memory locations have been filled or the entire FM band has been scanned three times or the **Auto Preset** button **L** is pressed again.

NOTE: Using the automatic tuning mode in areas with more than 30 FM stations will completely fill the preset memories, and overwrite any previously memorized presets for either AM or FM stations.

TIP: The automatic scan process may enter stations that you do not wish to retain in the memory, or it may enter the same station on the same frequency (if more than one scan is made) or on more than one frequency. These unwanted stations may be removed from the memory using the Preset Clear function outlined below.

Recalling Preset Stations

- To manually select a station previously entered in the preset memory, press the **Numeric Keys K** that correspond to the desired station's memory location.
- To manually tune through the list of stored preset stations one by one, press the **Preset** buttons **15 D** on the front panel or remote.
- To automatically scan through the stations entered in the preset memory, press the **Preset Scan** button **12 Q** on the front panel or remote. The tuner will cycle through the list of preset stations, stopping for five seconds at each one. Press the button again to stop the scan at your desired station.

Clearing Preset Stations

Unwanted preset stations may be erased from the unit's memory to make it easier to tune only those stations you want.

To remove a preset station from the HK 3490/HK 3390's tuner memory, first tune to the station using the **Preset** buttons **15 D** on the front panel or remote, or by entering the preset number directly, using the **Numeric Keys K**.

When the preset station to be removed has been tuned, first press the **Memory** button **9**. The words **MEMORY PRESET** will appear in the display, and the preset position number will flash. Next, press the **Clear** button **N** within five seconds.

The preset station will be removed from the memory, and the action will be confirmed by the brief appearance of the word **CLEAR** and the preset number location in the Main Information Display. That memory location will now be empty, and you may program a different station to that location, or leave it empty.

Operation

RDS Operation

RDS (Radio Data System) transmits station call signs or network information, station program type, text messages about the station or specifics of a musical selection and the correct time.

RDS Display Options

When an RDS station is tuned, press **RDS Display** button **Y** on the remote or **FM 17** on the front panel to cycle through the RDS displays in the following order:

- The Station name (or other Program information with some private stations).
- The station's frequency.
- The Program Type (PTY) as shown in the following list in this manual.
- A "text" message (RT) containing special information from the broadcast station. Note that this message will scroll across the display to permit messages longer than the eight positions in the display. Depending on signal quality it may take up to 30 seconds for the text message to appear, in the meantime the word **TEXT** will flash in the display when RT is selected.
- The current time of day (CT) as transmitted by the station. It may take up to two minutes for the time to appear, in the meantime the word **TIME** will flash in the display when CT is selected. Note that the accuracy of the time message is set by the radio station, not the HK 3490/HK 3390.
- Some RDS stations may not choose to include some of these additional features. If the data required for the selected mode is not being transmitted, the **Information Display** will show a **NØ PTY, NØ TEXT** or **NØ TIME** message after the individual time out.
- In any FM mode the RDS function requires a strong enough signal for proper operation. If you receive a partial message or see any RDS indicator going on and off, try slowly adjusting the antenna to improve the signal strength or tune to another, stronger, RDS station.

Program Search (PTY)

A major benefit of RDS is its ability to encode broadcasts with Program Type (PTY) codes that indicate the type of material being broadcast. The following list shows the abbreviations used to indicate each PTY along with an explanation of the PTY:

- **RDS ØNLY**: (see item 3 below)
- **POP M**: Popular Music
- **ROCK M**: Rock Music
- **M · Ø · R M**: Middle-of-the-Road Music
- **LIGHT M**: Classical Music
- **CLASSICS**: Serious Classical Music
- **ØTHER M**: Other Music
- **NEWS**: News
- **INFO**: Information
- **SPORT**: Sports
- **AFFAIRS**: Current Affairs
- **EDUCATE**: Educational
- **DRAMA**: Drama
- **CULTURE**: Culture
- **SCIENCE**: Science
- **VARIED**: Varied Speech Programs
- **WEATHER**: Weather Information
- **FINANCE**: Financial Programs
- **CHILDREN**: Children's Programs
- **SOCIAL**: Social Affairs Programs
- **RELIGION**: Religious Broadcasts
- **PHONE IN**: Phone-In Programs
- **TRAVEL**: Travel and Touring
- **LEISURE**: Leisure and Hobby
- **JAZZ**: Jazz Music
- **COUNTRY**: Country Music
- **NATION M**: National Music
- **ØLDIES**: Oldies Music
- **FOLK M**: Folk Music
- **DOCUMENT**: Documentary Programs
- **TEST**: Station Alarm Test Message
- **ALARM**: Emergency Broadcast Information

You may search for a specific Program Type (PTY) by following these steps:

1. Press the **RDS PTY** button **Z** and note that the Information Display will show **PTY FLASHING**.

2. After three seconds, the display will show the PTY that was selected for the last PTY search. If you wish to use the same PTY, press the **RDS PTY** button **Z** again within six seconds, and the tuner will begin to search for the first station with the appropriate PTY and acceptable signal strength.

3. To search for a different PTY, press the **Preset Up/Down** buttons **Ø15** while the last PTY selected is still displayed to scroll through the list of available PTY types. To search for the next available station with any RDS data, select **RDS ØNLY** as the PTY type.

4. When the PTY is selected, press the **Tune Up/Down** Button **Ø10** within six seconds. The HK 3490/HK 3390 will go into an automatic search mode and attempt to find the next station with acceptable signal strength that matches the desired PTY type. Press the **RDS PTY** button **Z** twice again to find another matching station. When a station is tuned, the search will stop, a message **RDS** will blink in the **Information Display** and then the Display will show the station's "Call Letters" or other "Program Service" information.

5. While the **PTY Indicator** flashes in the display the tuner will make one complete scan of the entire FM band for the text station that matches the desired PTY type and has acceptable reception quality. If no such station is found, the word **NONE** will appear briefly in the Information Display, and the tuner will return to the last FM station in use before the search. To turn off the PTY Search at any time, press the **RDS PTY** button **Z** again.

NOTE: Many stations do not transmit a specific PTY. The display will show **NONE**, when such a station is selected and PTY is active.

Operation

Tape Recording

In normal operation, the audio source selected for listening through the HK 3490/HK 3390 is sent to the **Tape Mon Rec Out 10** and **Video 1 Record Outputs 11** outputs. This means that any program you are listening to may be recorded simply by placing machines connected to the outputs for **Tape Monitor 10** or **Video 1 11** in the record mode. Moreover the source connected to **Video 1 Input 8** may be recorded to a recorder connected to **Tape Mon 9/10**, rather than turned around.

When a tape recorder with separate record and playback heads is used, you may monitor the output of the recording by selecting the **Tape Monitor Input Selector 9 C**. Note that the **TAPE M. Indicator** will light in the **Main Information Display 25** to remind you that you are listening to the record playback instead of the actual input source being recorded.

As long as **Tape Monitor 9 C** is selected the previously selected input source remains routed to the **Record Outputs 10 12**. Press the **Tape Monitor Input Selector 9 C** again to turn the monitoring off and listen to the actual input source. Note that changing the Bass, Treble or Balance control will not affect the recordings, only the preamp and speaker outputs.

Memory Backup

This product is equipped with a memory backup system that preserves tuner presets if the unit is accidentally unplugged, turned off completely by disconnecting from the main power source or subjected to a power outage.

The unit's memory is stored in an EEPROM, and thus the HK 3490/HK 3390 will retain information such as programmed presets for a virtually infinite time without being connected to a main power source.

Processor Reset

In the rare case where the unit's operation or the displays seem abnormal, the cause may involve the erratic operation of the system's memory or microprocessor.

To correct this problem, first unplug the unit from the AC wall outlet and wait at least three minutes. After the pause, reconnect the AC power cord and check the unit's operation. If the system still malfunctions, a system reset may clear the problem. To reset the system, first turn the HK 3490/HK 3390 off either by pressing the **Main Power Switch** on the rear panel **29** to OFF, or disconnecting the unit from the main power source.

Next, press and hold the **MUTE 5** and the **Preset Scan 12** buttons at the same time on the front panel ONLY. When the receiver switches On and the Main Information Display shows the word **RESET**, release both buttons. The receiver returns to Standby Mode.

Note that when the system is reset in this fashion, all tuner presets will be lost and must be reentered.

If the system is still operating incorrectly, there may have been an electronic discharge or severe AC line interference that has corrupted the memory or microprocessor. If these steps do not solve the problem, consult your dealer or an authorized Harman Kardon service center.

Using The Bridge (HK 3490 only)

When Harman Kardon's **The Bridge** (optional) is connected and a compatible Apple® iPod® is docked in The Bridge, press the **The Bridge DMP Selector Button 8** until "The Bridge" appears in the Display to choose the iPod as the input source, allowing playback of audio materials on your iPod through your high-quality audio system. Pressing the **The Bridge DMP Selector Button 8** will also activate the remote's control codes for the iPod.

When The Bridge is properly connected and a compatible iPod is properly docked, the **Display** will read **DMP / CONNECTED**.

Once that message appears, use the remote to control the iPod. See the Function List Table further down on this page for a listing of the remote control buttons that have been programmed to control the iPod. In brief, the **Skip Down, Play and Skip Up Buttons D** and the **▲/▼/◀▶ Buttons F** and **OK Button X** may be used in a similar manner to the corresponding controls on the iPod. More complete details on operating an iPod using **The Bridge** and the HK remote are furnished with **The Bridge**.

NOTES:

- The Play and Pause functions are not available unless content has been selected for playback by navigating the menu system.

While a selection is playing, the song title, artist and album name, if available on the iPod, will scroll across the upper line in the **Display 25**. The lower line will display the elapsed time of the track on the left, the play mode icon, and the time remaining on the right.

When your iPod is docked in The Bridge and playing, you can choose to either use the display on the iPod or switch to the receiver's display for information. To switch to the receiver display, press and hold the **Menu M** Button until the iPod shows a large checkmark and the text "harman kardon" in its display. Now the receiver display shows song title etc. as described above.



You may now enter the iPod's menu system by again pressing and holding the **Menu M** Button, to show MENU in the receiver display. You can navigate in the MUSIC menu structure just like you would do directly on the iPod. However, if you select one of the other menus, such as the SETTINGS Menu, the active display will revert to the iPod itself. When you have performed the changes you wish in Settings or other menus, revert to the receiver's display by once more pressing and holding the **Menu M** Button on the Remote. If you have entered the MENU function on the receiver display, but wish to exit without changes, just wait a few seconds, and the MENU option disappears again.

You may also change back from the receiver display to the iPod display again by repeating the same procedure: press and hold the **Menu M** Button until the iPod display becomes active again.

Operation

Using the Remote Control

It is convenient to think of the functions of the remote control buttons in terms of "pages", where each source device (e.g. CD player) represents its own page of remote functions. The result is that some of the keys will perform different functions depending upon which device page has been selected prior to pressing the

key. Device pages are selected by pressing the **Source Selectors** , which also changes the input source selection on the HK 3490/HK 3390. **Source Selectors**  need not to be pressed with each function, but only when you intend to skip to another device to be controlled.

The Video 1, Video 2, Video 3, Tape Monitor/CDR and CD device pages are factory-programmed to

operate compatible Harman Kardon products.

Video 1 controls Harman Kardon DMC players, Video 2 and 3 controls Harman Kardon DVD players, Tape Monitor controls Harman Kardon CDR players/recorders, CD controls Harman Kardon CD players. Please refer to the table below for specific information on the default functions of the affected keys for these devices.

REMOTE BUTTON FUNCTIONS

Button Name	Phone	Harman Kardon DMC	Harman Kardon DVD	VID 3/VID Front	Harman Kardon CDR	Harman Kardon CD	AM	FM	HK 3490 only
		VID 1	VID 2		TAPE MON	CD			The Bridge
Power ON	System Power On	System Power On DMC Power On	System Power On DVD Power On	System Power On	System Power On CDR Power On	System Power On CD Power On	System Power On	System Power On	System Power On
Power Off	System Power Off	System Power Off DMC Power Off	System Power Off DVD Power Off	System Power Off	System Power Off CDR Power Off	System Power Off CD Power Off	System Power Off	System Power Off	System Power Off
Speakers 1	Speaker 1	Speaker 1	Speaker 1	Speaker 1	Speaker 1	Speaker 1	Speaker 1	Speaker 1	Speaker 1
Speakers 2	Speaker 2	Speaker 2	Speaker 2	Speaker 2	Speaker 2	Speaker 2	Speaker 2	Speaker 2	Speaker 2
Phono	Phono	Phono	Phono	Phono	Phono	Phono	Phono	Phono	Phono
CD	CD CD Power On	CD CD Power On	CD CD Power On	CD CD Power On	CD CD Power On	CD CD Power On	CD CD Power On	CD CD Power On	CD CD Power On
VID 1	VID 1 DMC Power On	VID 1 DMC Power On	VID 1 DMC Power On	VID 1 DMC Power On	VID 1 DMC Power On	VID 1 DMC Power On	VID 1 DMC Power On	VID 1 DMC Power On	VID 1 DMC Power On
VID 2	VID 2 DVD Power On	VID 2 DVD Power On	VID 2 DVD Power On	VID 2 DVD Power On	VID 2 DVD Power On	VID 2 DVD Power On	VID 2 DVD Power On	VID 2 DVD Power On	VID 2 DVD Power On
VID 3	VID 3/VID Front	VID 3/VID Front	VID 3/VID Front	VID 3/VID Front	VID 3/VID Front	VID 3/VID Front	VID 3/VID Front	VID 3/VID Front	VID 3/VID Front
FM	FM	FM	FM	FM	FM	FM	FM	FM	FM
AM	AM	AM	AM	AM	AM	AM	AM	AM	AM
Tape Mon.	Tape Mon/CDR CDR Power On	Tape Mon/CDR CDR Power On	Tape Mon/CDR CDR Power On	Tape Mon/CDR CDR Power On	Tape Mon/CDR CDR Power On	Tape Mon/CDR CDR Power On	Tape Mon/CDR CDR Power On	Tape Mon/CDR CDR Power On	Tape Mon/CDR CDR Power On
The Bridge (3490 only)	The Bridge	The Bridge	The Bridge	The Bridge	The Bridge	The Bridge	The Bridge	The Bridge	The Bridge
FM Mode		DMC Status	DVD Status		CDR Time			FM Mode	FM Mode
DSP Mode (3490 only)	Surround Mode	Surround Mode	Surround Mode	Surround Mode	Surround Mode	Surround Mode		Surround Mode	Surround Mode
Auto Preset		DMC Subtitle	DVD Subtitle		CDR Finalize	CD Program Check	Auto Preset	Auto Preset	
1		1	1	1	1	CD 1	1	1	
2		2	2	2	2	CD 2	2	2	
3		3	3	3	3	CD 3	3	3	
4		4	4	4	4	CD 4	4	4	
5		5	5	5	5	CD 5	5	5	
6		6	6	6	6	CD 6	6	6	
7		7	7	7	7	CD 7	7	7	
8		8	8	8	8	CD 8	8	8	
9		9	9	9	9	CD 9	9	9	
Direct		DMC Info	DVD Info	DVD Chapter	CDR Track Direct	CD Source	Frequency Direct	Frequency Direct	
0		0	0	0	0	CD 0	0	0	
Clear		DMC Clear	DVD Clear	DVD Clear	CDR Clear	CD Clear	Clear	Clear	
Memory		DMC Return	DVD Play Mode	DVD Return	CDR Program	CD Repeat	Memory/Store	Memory/Store	
Cursor Up	Cursor Up	DMC Up (Navigation)	DVD Up (Navigation)	DVD OSD Up	CDP Select	CD Folder +	Preset Tuning ->	Preset Tuning ->	Cursor Up
Menu	Menu	DMC Setup	DVD Setup	DVD Menu		CD Time			Menu
Cursor Left	Cursor Left	DMC Left (Navigation)	DVD Left (Navigation)	DVD OSD Left	CDR Volume Down	CD 10 -			Cursor Left
Enter	Enter	DMC Enter	DVD Enter	DVD Enter	CDR Random Play	CD Play/Pause			Enter
Cursor Right	Cursor Right	DMC Right (Navigation)	DVD Right (Navigation)	DVD OSD Right	CDR Volume Up	CD 10 +			Cursor Right
Preset Scan		DMC Title	DVD Title	DVD Intro Scan	CDR Intro Scan	CD Random	Preset Scan	Preset Scan	
Cursor Down	Cursor Down	DMC Down (Navigation)	DVD Down (Navigation)	DVD OSD Down	CDR Select	CD Folder -	Preset Tuning <-	Preset Tuning <-	Cursor Down
Disc Menu		DMC disc Menu	DVD disc Menu	DVD disc Menu		CD Info			
Volume Up	Volume Up	Volume Up	Volume Up	Volume Up	Volume Up	Volume Up	Volume Up	Volume Up	Volume Up
Mute	Audio Mute	Audio Mute	Audio Mute	Audio Mute	Audio Mute	Audio Mute	Audio Mute	Audio Mute	Audio Mute
Tuning Up >>		DMC Zoom	DVD Zoom	DVD Page +	CDR Disc Skip +	=====	Tuning Up	Tuning Up	
Volume Down	Volume Down	Volume Down	Volume Down	Volume Down	Volume Down	Volume Down	Volume Down	Volume Down	Volume Down
Tuning Down <<		DMC Audio	DVD Audio	DVD Page -	CDR Disc Skip -	=====	Tuning Down	Tuning Down	
Preset Down I<<	Skip <<	DMC Prev/Step	DVD Prev/Step	DVD Skip Back	CDR Skip <<	CD Previous	Preset Tuning <<	Preset Tuning <<	Skip <<
Pause II	Pause	DMC Pause	DVD Pause	DVD Pause	CDR Pause	CD Play/Pause			Pause
Preset Up >>I	Skip >>	DMC Next/Step	DVD Next/Step	DVD Skip Forward	CDR Skip >>	CD Next	Preset Tuning >>	Preset Tuning >>	Skip >>
Search Backward <<		DMC Search/Slow <<	DVD Search/Slow <<	DVD Search <<	CDR Search <<	CD Search -			
Play	Play	DMC Play	DVD Play	DVD Play	CDR Play	CD Play/Pause			Play
Search Forward >>		DMC Search/Slow >>	DVD Search/Slow >>	DVD Search >>	CDR Search >>	CD Search +			
Rec		DMC Record	DVD Video Off		CDR Record				
Stop		DMC Stop	DVD Stop	DVD Stop	CDR Stop	CD Stop			
Dimmer	Dimmer	DMC Dimmer	DVD Dimmer	Dimmer	Dimmer	CD Display	Dimmer	Dimmer	Dimmer
RDS Display		DMC Video Mode	DVD Video Resolution			CD Program		RDS Display	
RDS PTY		DMC Source				CD Check		RDS PTY	
Sleep	Sleep Timer	Sleep Timer	Sleep Timer	Sleep Timer	Sleep Timer	Sleep Timer	Sleep Timer	Sleep Timer	Sleep Timer

Troubleshooting Guide

This unit is designed for trouble-free operation. Most problems users encounter are due to operating errors. If you have a problem, first check this list for a possible solution. If the problem persists, consult your authorized Harman Kardon Service Center.

If the problem is...	Make sure that the...
No lights appear when System Power 2 button is pressed	Unit is plugged into a live outlet.
No sound is heard	Unit has not been muted. Correct input function selector button has been pressed. Volume is turned up. Speakers have been turned on using the Speaker Selectors 67UV .
No output from one or more channels	Cables are not defective: check/replace speaker cables.
Tuner sound has a large amount of interference, or the "Stereo" display is not illuminated, or Tuner sound distorts and/or is noisy	Antenna is properly connected. Antenna is properly located. Antenna is set in the proper direction. Antenna is adequate to receive the desired station.
Tuner is intermittent or continuously buzzing or hissing	Unit is away from fluorescent lights, TVs, motors and other electrical appliances.
Remote does not function correctly	Batteries are not weak, and replace them if necessary. Correct device page has been selected by pressing the Source Selector key C . Remote sensor is not obstructed, and remote is pointing directly at sensor at an angle of no more than 30 degrees. Also, check for fluorescent lighting, which may be interfering with the IR transmission.
Cassette or CD sounds distorted	Cassette deck or CD player has not been plugged into the Phono input. (Only use the outputs of a turntable or tonearm with the Phono input.)
Turntable sounds distorted	Turntable has been plugged into the Phono Input 6 , as the other inputs are not compatible with turntable signal levels
No video image	Video source unit's video output is properly connected, the source is turned on and the correct video input on the HK 3490/HK 3390 has been selected Video Monitor Output 2 is connected to a TV or video display, and that the TV is turned on and the proper input on the TV has been selected

Technical Specifications

Audio Section

Stereo Mode
Continuous Average Power (FTC)
HK 3490: 120 Watts per channel, 20Hz–20kHz
@ < 0.07% THD, both channels driven into 8 ohms
HK 3390: 80 Watts per channel, 20Hz–20kHz @ < 0.07% THD,
both channels driven into 8 ohms

Input Sensitivity/Impedance
Linear (High Level) 200mV/47kohms

Signal-to-Noise Ratio (IHF-A) 95dB

Frequency Response
@ 1W (+0dB, -3dB) 10Hz–110kHz

High Instantaneous
Current Capability (HCC) HK 3490: ±45Amps
HK 3390: ±42Amps

Transient Intermodulation
Distortion (TIM) Unmeasurable

Rise Time 16 µsec

Slew Rate 40V/µsec

FM Tuner Section

Frequency Range 87.5–108MHz
Usable Sensitivity IHF: 1.3µV/13.2dBf
Signal-to-Noise Ratio Mono/Stereo: 73/72dBA (DIN)
Distortion Mono/Stereo: 0.2/0.3%
Stereo Separation 40dB @ 1kHz
Selectivity ±400kHz, 65dB
Image Rejection >80dB
IF Rejection >100dB

AM Tuner Section

Frequency Range 522–1620kHz
Signal-to-Noise Ratio >40dB
Usable Sensitivity Loop: 500µV/M
Distortion 1kHz, 50% Mod: 0.8%
Europe: ±9kHz

Video Section

Television System NTSC/PAL/SECAM
Signal Format Composite
Input Level 1Vp-p
Input Impedance 75 ohms, unbalanced
Sync Polarity Negative
Output Level 1Vp-p
Output Impedance 75 ohms, unbalanced
Video Frequency Response 10Hz – 10MHz

General

Power Requirement AC 230V/50Hz
Power Consumption HK 3490: 3W standby, 310W maximum
(both channels driven)
HK 3390: 3W standby, 230W maximum
(both channels driven)

Dimension (Max)

Width 440mm
Height 165mm
Depth 382mm
Weight HK 3490: 10.4kg
HK 3390: 9.5kg

Depth measurement includes knobs, buttons and terminal connections. Height measurement includes feet and chassis.

All features and specifications are subject to change without notice.

Harman Kardon and Power for the Digital Revolution are registered trademarks of Harman International Industries, Incorporated.

harman/kardon

H A Harman International Company
250 Crossways Park Drive, Woodbury, New York 11797
www.harmankardon.com
Harman Consumer International:
2, Route de Tours, 72500 Château-du-Loir, France
© 2008 Harman Kardon, Incorporated
Part CQX1A1329Z

